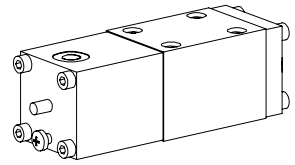

Spool valve pneumatically operated

- 4/2-way impuls version detented
- 4/3-way with spring centered mid position
- 4/2-way with spring reset
- $Q_{max} = 60 \text{ l/min}$, $p_{max} = 350 \text{ bar}$

NG6
ISO 4401-03

DESCRIPTION

Spool valve NG6, flange type in accordance to ISO 4401-03 standard with 4 connections. Directly and pneumatically operated spool valve in a 5 chamber system. Spool blocked or with spring reset. Spool type pneumatic head, precise spool fit, small leakage, long life. Threaded connection by means of additional connecting plate. Spool made from hardened steel, the valve body is made from a high quality casting suitable for hydraulic applications. The valve bodies are painted. The end covers and the pneumatic heads are zinc coated.

FUNCTION

When actuated, the pneumatic head displaces the valve spool to the corresponding switching position.

- 4/2-way impulse spool valve:
2 pneumatic head and 2 locking switch positions. When the pneumatic head is not actuated, the spool is held by the lock in the corresponding switching position.
- 4/3-way spool valve:
2 pneumatic heads and 3 switching position. When the air head is not actuated, the spool is switched back to the centre position via the springs.
- 4/2-way spool valves:
1 pneumatic head and 2 switching positions. When the pneumatic head is not actuated, the spool is switched back to the home position by the spring.

APPLICATION

Pneumatically operated spool valves are mainly used to control the direction of movement and for retaining hydraulic cylinders and motors. The direction of movement is determined by the position of the valve spool and its symbol. Pneumatically operated valves are particularly suitable for use in areas where there is a risk of explosion in the chemical or mining industries and also in industrial installations where compressed air is used.

CONTENT

GENERAL SPECIFICATIONS	1
HYDRAULIC SPECIFICATIONS	1
CONTROL PNEUMATIC	1
TYPE CHARTS / SYMBOLS	2
CHARACTERISTICS	2
DIMENSIONS	3
PARTS LIST	3
ACCESSORIES	3

TYPE CODE

	A	K	4	#
International interface ISO				
Operation pneumatically				
No. of control ports				
Type charts/Symbols acc. to table 1.6-30/2				
Design-Index (Subject to change)				

GENERAL SPECIFICATIONS

Description	4/2-, 4/3-way valve
Nominal size	NG6 to ISO 4401-03
Constructions	Direct operated spool valve
Operations	Pneumatically
Mounting	Flange 4 fixing holes for socket head cap screws M5x45
Connections	Threaded connection plates Multi-flange plates Longitudinal stacking system
Ambient temperature	-20...50°C
Mountin position	any, preferably horizontal
Fastening torque	$M_D = 5,5 \text{ Nm}$ (screw quality 8.8)
Weight:	
4/2-way impuls	$m = 2,0 \text{ kg}$
4/3-way	$m = 2,0 \text{ kg}$
4/2-way (1 control head)	$m = 1,6 \text{ kg}$

HYDRAULIC SPECIFICATIONS

Fluid	Mineral oil, other fluid on request
Contamination efficiency	ISO 4406:1999, class 20/18/14 (Required filtration grade $\beta_{10...16} \geq 75$) refer to data sheet 1.0-50/2
Viscosity range	12 mm ² /s...320 mm ² /s
Fluid temperature	-20...+70°C
Operating pressure	
in port P, A, B	$p_{max} = 350 \text{ bar}$
Tank pressure	
in port T	$p_{max} = 200 \text{ bar}$
Max. Volume flow	$Q_{max} = 60 \text{ l/min}$, see characteristics
Leakage volume flow	see characteristics

CONTROL PNEUMATIC operated with control head

Min. pilot pressure	$p_{st' \text{ min}} = 1,5 \text{ bar}$ at $p_T = 20 \text{ bar}$
	$p_{st' \text{ min}} = 5 \text{ bar}$ at $p_T = 200 \text{ bar}$
Control volume	$V_{st} = 6,9 \text{ cm}^3$

TYPE LIST / DESIGNATION OF SYMBOLS

4/2-way valve impulse

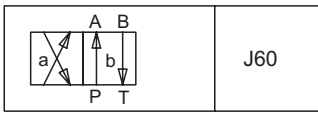

J60

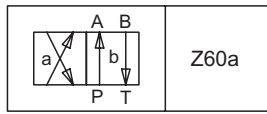
 4/2-way valve with spring reset
 operation A-side

Z60a

operation B-side

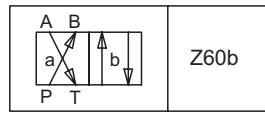

Z60b

Transitional functions

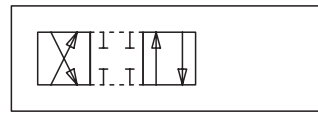

4/3-way valve spring centered

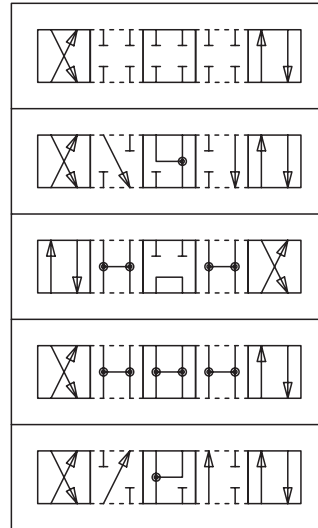
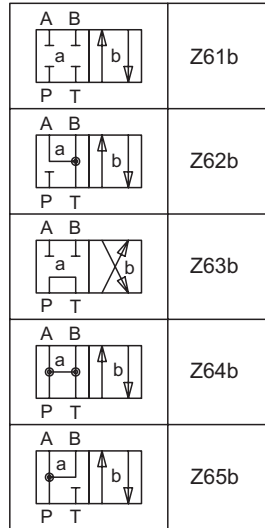
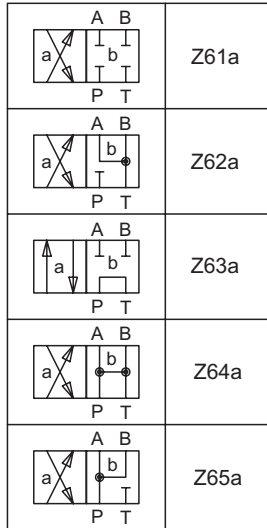
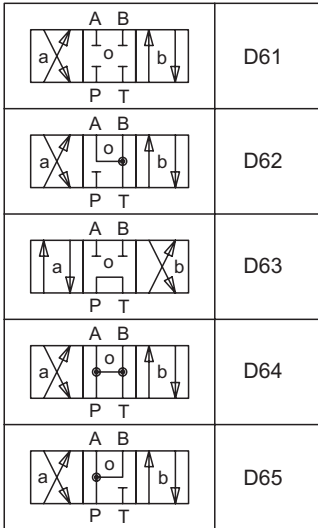
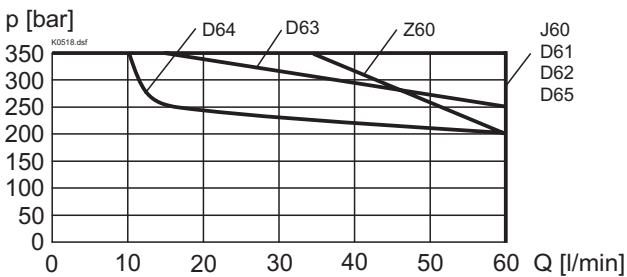
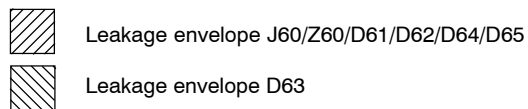
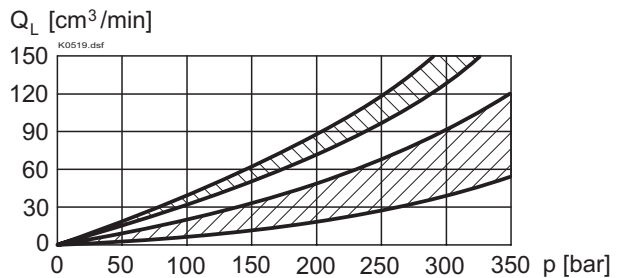
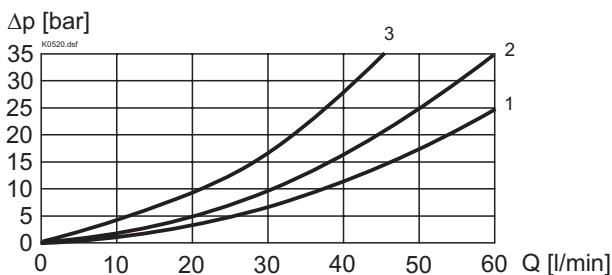

CHARACTERISTICS Oilviscosity $\nu = 30 \text{ mm}^2/\text{s}$
 $p = f(Q)$ Performance limits

 $Q_L = f(p)$ Leakage volume flow characteristics
 per control edge

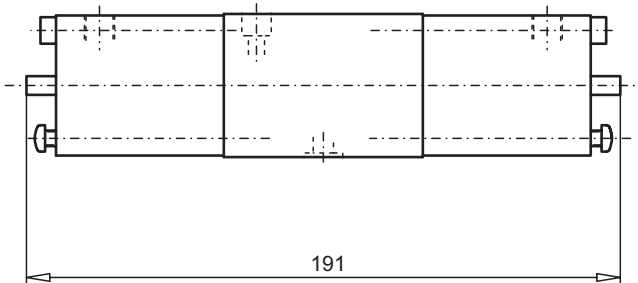
 $\Delta p = f(Q)$ Pressure drop volume flow characteristics

Symbol	Pressure drop Curve no.	Volume flow direction				
		P - A	P - B	P - T	A - T	B - T
Z60/J60	2	2	2	-	2	2
D61/Z61	2	2	2	-	2	2
D62/Z62	2	2	2	-	2	2
D63/Z63	2	2	2	3	2	2
D64/Z64	1	1	1	-	1	1
D65/Z65	1	1	1	-	2	2

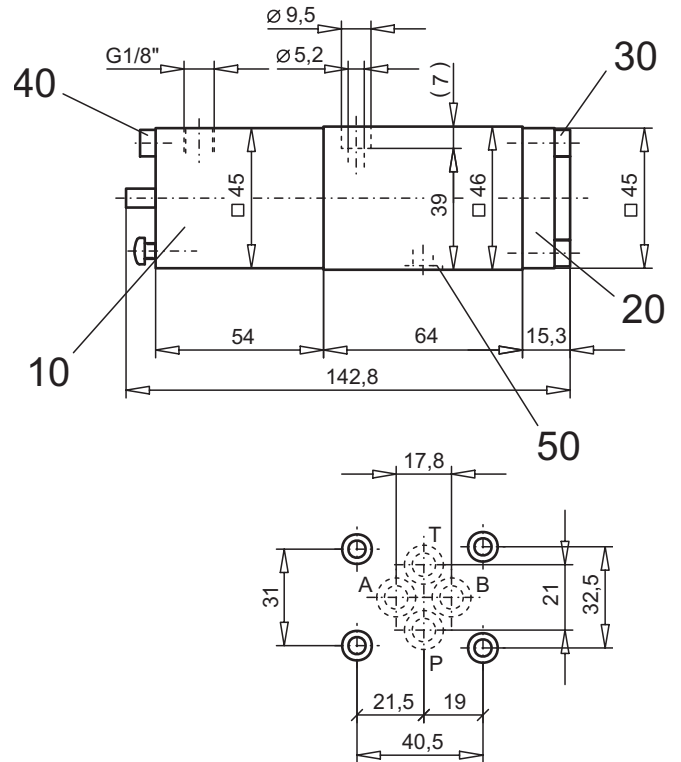
DIMENSIONS

 4/3-way valve (spring centred)
 4/2-way valve (impulse)

4/2-way valve (spring reset)

PARTS LIST

Position	Article	Description
10	254.4050	Control head CKII
20	058.4200	Cover
30	246.2117	Socket head cap screw M5x16 DIN 912
40	246.2160	Socket head cap screw M5x60 DIN 912
50	160.2093	O-ring ID 9,25x1,78

ACCESSORIES

 Threaded connection plates, Multi-flange plates
 and longitudinal stacking system

register 2.9

Technical explanation see data sheet 1.0-100E