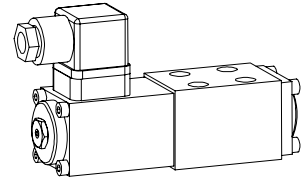

Solenoid operated spool valve

- 4/2-way impulse valve
- 4/3-way with spring centred mid position
- 4/2-way with spring reset
- $Q_{max} = 20 \text{ l/min}$, $p_{max} = 350 \text{ bar}$

NG4
 ISO 4401-02

DESCRIPTION

Spool valve in flange design NG4 in accordance with ISO 4401-02. Interface to Wandfluh standard with 4 ports. Solenoid to standard VDE 0580. Direct operated solenoid valve in 5 chamber design. Spool detented or with spring reset. Wet pin type solenoid. Precise spool fit, low leakage, long life time. Threaded ports through additional base plate. Spool made from hardened steel, body from high quality cast steel. Wide range of standard and special voltages in 2 solenoid versions. The body made of high grade hydraulic casting for long service life is painted. The cover and the solenoid are zinc coated.

FUNCTION

The solenoid shifts the spool into the corresponding position.

- 4/2-way detented spool valve:
2 solenoids and 2 detented positions. With the solenoids deenergised the spool remains in the last switched position.
- 4/2-way spool valve:
1 solenoid and 2 spool positions, spring offset. With the solenoid deenergised the spool returns to the offset position.
- 4/3-way spool valve:
2 solenoids and 3 spool positions, spring centered. With the solenoids deenergised the spool returns to the center position.

APPLICATION

Solenoid operated spool valves are mainly used for controlling direction of movement and stopping of hydraulic cylinders and motors. Direction of movement depends on the position of spool and its flow symbol. Please pay attention to the performance limits and leakage of the valves. Solenoid operated spool valves are suitable for machine tools and handling systems.

CONTENT

GENERAL SPECIFICATIONS	1
HYDRAULIC SPECIFICATIONS	1
ELECTRICAL SPECIFICATIONS	2
SOLENOID DESCRIPTION	2
TYPE LIST/ DESIGNATIONS OF SYMBOLS	2
CHARACTERISTICS	2/3
DIMENSIONS	3
SECTIONAL DRAWING	3
PARTS LIST	3
ACCESSORIES	3

TYPE CODE

Spool valve direct operated	WD	<input type="checkbox"/>	F	B04	-	<input type="checkbox"/>	-	<input type="checkbox"/>	#	<input type="checkbox"/>
Economy-solenoid	<input type="checkbox"/>	E								
Medium-solenoid	<input type="checkbox"/>	M								
Flange type										
International standard interface ISO nominal size 04										
Description of symbol refer to table 1.2-51/2										
Standard-Nominal voltage U_N :	12 VDC	<input type="checkbox"/>	G12							
	24 VDC	<input type="checkbox"/>	G24							
	110 VAC	<input type="checkbox"/>	R110							
	115 VAC	<input type="checkbox"/>	R115							
	230 VAC	<input type="checkbox"/>	R230							
Design-Index (Subject to change)										

GENERAL SPECIFICATIONS

Designation	4/2-, 4/3-way directional control valve
Nominal size	4 according to ISO 4401-02
Type	Direct operated spool valve
Operations	Solenoid
Type of mounting	Flange 4 fixing holes for socket head cap screws M5x40 Screw fitting connection plates
Connections	
Ambient temperature	-20...+50° C
Mounting position	any, preferably horizontal
Fastening torque	$M_D = 5,5 \text{ Nm}$ (quality 8.8)

Weight	Economy	Medium
4/2-way impulse	m = 1,2 kg	m = 1,4 kg
4/3-way	m = 1,2 kg	m = 1,4 kg
4/2-way(1 solenoid)	m = 0,83 kg	m = 0,93 kg

HYDRAULIC SPECIFICATIONS

Fluid	Mineral oil, other fluid on request
Contamination efficiency	ISO 4406:1999, classe 20/18/14 (Required filtration grade $\beta_{10...16} \geq 75$) refer to data sheet 1.0-50/2
Viscosity range	12 mm ² /s...320 mm ² /s
Fluid temperature	-20...+70° C
Operating pressure in port P, A, B	Economy: $p_{max} = 250 \text{ bar}$ Medium: $p_{max} = 350 \text{ bar}$
Tank pressure in port T	$p_{max} = 100 \text{ bar}$
Max. volume flow	$Q_{max} = 20 \text{ l/min}$
Leakage volume flow	see characteristics

ELECTRICAL SPECIFICATIONS

Construction	Solenoid, wet pin push type, pressure tight
Standard-Nominal voltage	$U_N = 12$ VDC
	$U_N = 24$ VDC
	$U_N = 110$ VAC*
	$U_N = 115$ VAC*
	$U_N = 230$ VAC*
	AC = 50 to 60 Hz
	* Rectifier integrated in the plug, other nominal voltages and nominal performances on request.
Voltage tolerance	±10% of nominal voltage
Protection class	IP 65 to EN 60 529
Relative duty factor	100% DF (see data sheet 1.1-430)
Switching cycles	15'000/h
Operating life	10^7 (number of switching cycles, theoretically)
Connection/Power supply	Over device plug connection to ISO 4400/ DIN 43650, (2P+E), other connections on request

SOLENOID DESCRIPTION

With respect to the selection of the solenoid, the following statements are important:

- The solenoid is the most expensive component of the solenoid spool valve.
- For this reason, it is not economical to use the same solenoid for all applications.
- Depending on the application, sales area, and customer, the requirements for solenoid spool valves and solenoids differ very considerably.
- In order to be able to offer the customer an optimum, we can supply our solenoid spool valves NG4 in 2 different versions
Solenoid:
 - Economy BEIIV (data sheet 1.1-100)
 - Medium SIN35V (data sheet 1.1-105)

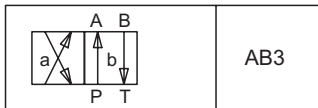
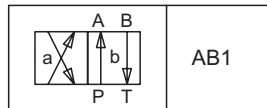
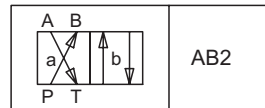
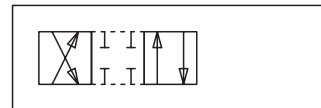
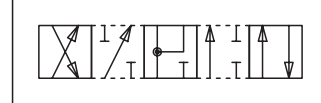
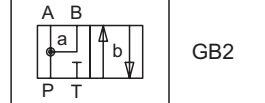
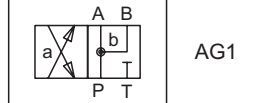
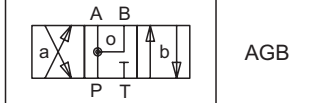
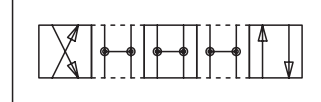
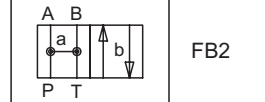
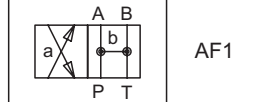
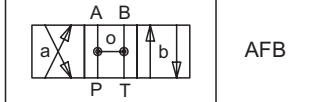
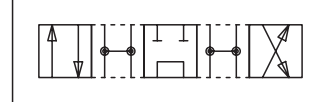
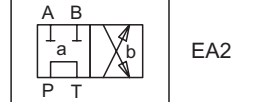
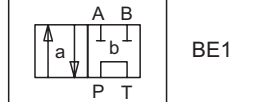
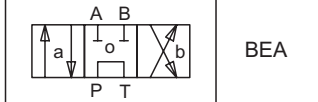
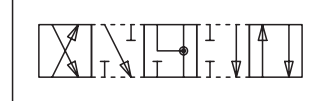
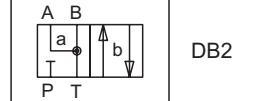
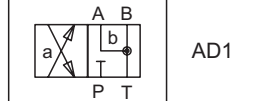
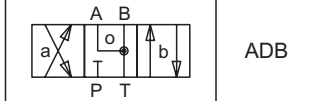
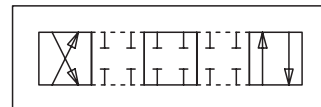
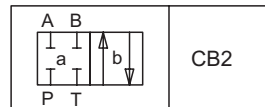
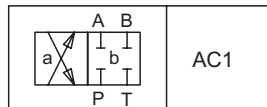
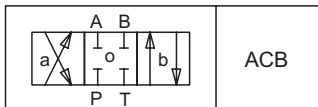

TYPE LIST / DESIGNATION OF SYMBOLS
4/2-way valve impulse

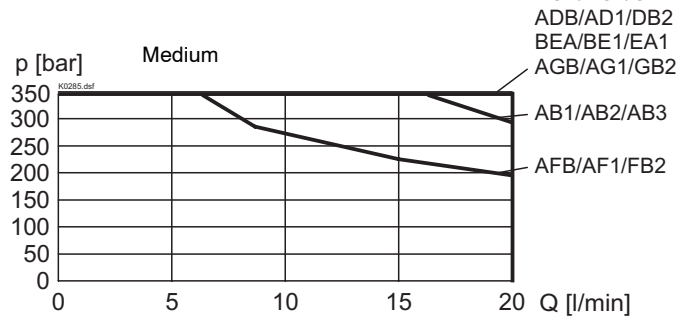
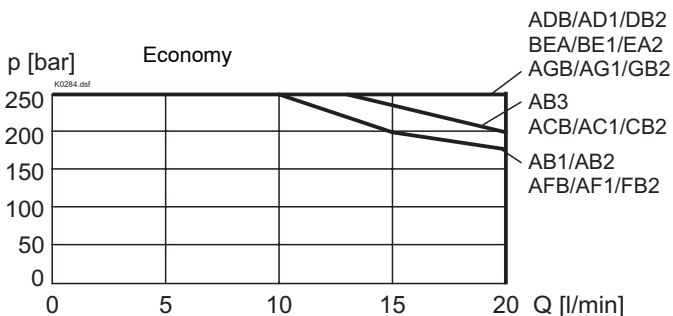
4/2-way valve with spring reset operation A-side

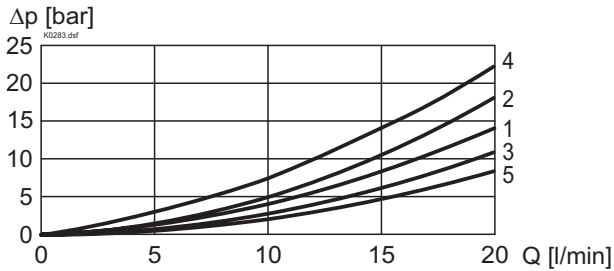
operation B-side

Transitional functions

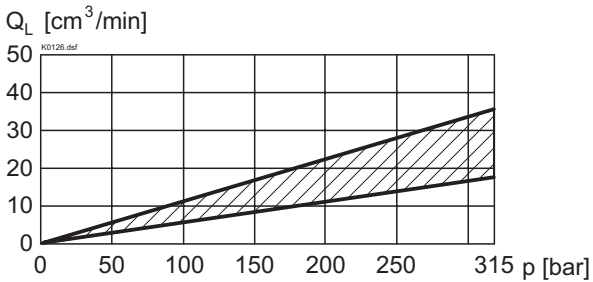
4/3-way valve spring centered

CHARACTERISTICS Oilviscosity $\nu = 30$ mm²/s

$p = f(Q)$ Performance limits with standard voltage -10%



$\Delta p = f(Q)$ Pressure drop volume flow characteristics

Pressure drop Curve no. Symbol	Volume flow direction				
	P - A	P - B	P - T	A - T	B - T
AB1/AB2/AB3	1	1	-	2	2
ACB/AC1/CB2	1	1	-	2	2
ADB/AD1/DB2	1	1	-	2	2
BEA/BE1/EA2	3	3	4	2	2
AFB/AF1/FB2	3	3	5	2	2
AGB/AG1/GB2	3	3	-	2	2

 $Q_L = f(p)$ Leakage volume flow characteristics
 per control edge

 Leakage envelope AB3/AB1/ACB/ADB/AFB/AGB

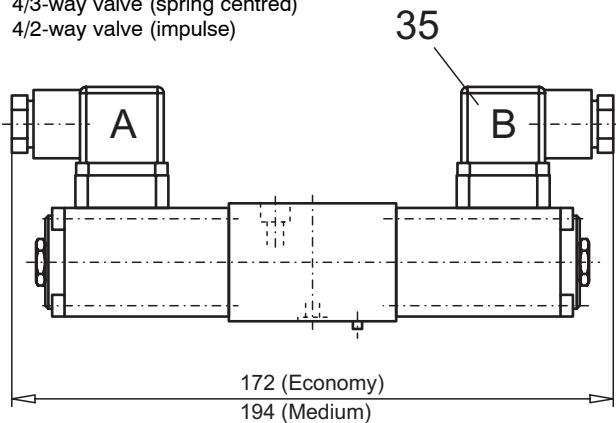
DIMENSIONS

 4/3-way valve (spring centred)
 4/2-way valve (impulse)

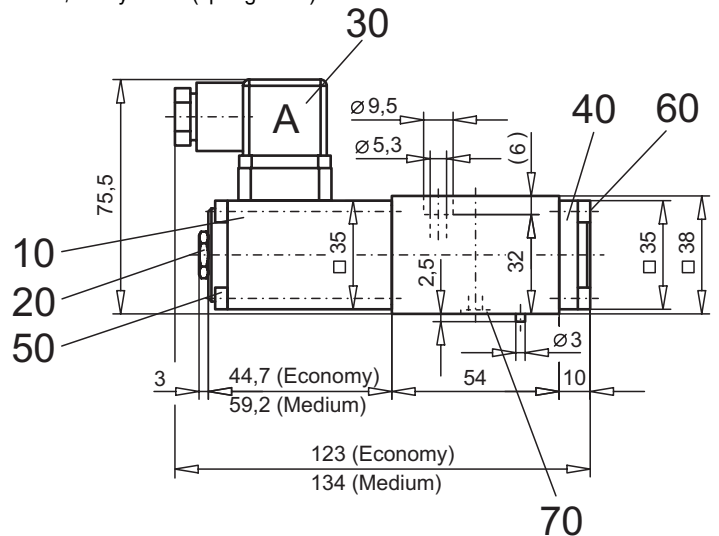
4/2-way valve (spring reset)

PARTS LIST

Position	Article	Description
10	260.1... 260.4...	Economy-solenoid BEIIV Medium-solenoid SIN35V
20	253.8000	Plug with integrated manual override HB4,5
30	219.2001	Electric plug A (grey)
35	219.2002	Electric plug B (black)
40	057.4202	Cover
50	246.1146 246.1161	Socket head cap screw M4x45 (BEIIV) Socket head cap screw M4x60 (SIN35V)
60	246.1113	Socket head cap screw M4x12 DIN 912
70	160.2060	O-ring ID 6,07x1,78

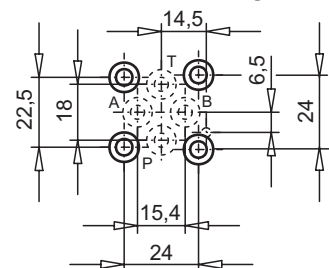
ACCESSORIES

Threaded connecting plates

see Reg. 2.9

Technical explanation see data sheet 1.0-100E